

3088

Unisex Beanie

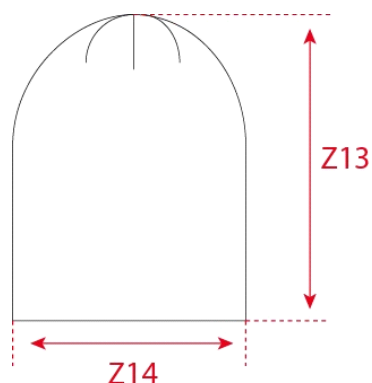





Maßtabelle (cm)

	One Size
Z13	30
Z14	26,5

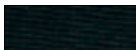
Z13 BEANIE LÄNGE
Z14 BEANIE BREITE

Farben

				
00/white 11-0601 TPX /TCX	9D/black 19-4205 TPX/TCX	03/sports grey 17-0000 TPX/TCX	SG/steel gray 18-0000 TCX	BY/burgundy 19-2014 TPX/TCX
				
54/navy 19-4025 TPX/TCX				



Artikel

3088
Unisex Beanie

Material

95% Baumwolle, 5% Elasthan

Gewicht

180 g/m²

Größen

One Size

Wasch-Anleitung



Verpackungseinheiten

VE = 5 Stück.
Karton = 100 Stück.

Angaben zu Maßen und Grammaturen +/- 5%. Änderungen vorbehalten.

Unisex Beanie

Artikelbeschreibung

Beanie, Single-Jersey, 95 % Baumwolle, 5 % Elasthan, 180 g/m², Einheitsgröße.

Kurzbeschreibung

Unisex-Single-Jersey-Beanie, doppellagig, Tear- Off-Label zum einfachen Heraustrennen, hergestellt aus gekämmter Baumwolle mit Elasthananteil für Formbeständigkeit.

Farbe sports grey: 81% Baumwolle, 14% Viskose, 5% Elasthan

Eigenschaften

Angaben zu Maßen und Grammaturen +/- 5%. Änderungen vorbehalten.

